

## PRODUCT SPECIFICATIONS

MODEL NO.	MOTOR	RPM		AMPS		HP	kW	NET WT.		CAPACITOR	
		60HZ	50HZ	60HZ	50HZ			lbs.	kg	mfd.	VOLT
87R642-443R-N470X	115-120/230-240 (60Hz) 110-120/220-240 (50Hz)	1725	1425	5.7/2.8	5.1/2.6	1/2	0.37	19.1	8.6	30	370

SOUND LEVEL <65 db(A)

NORMAL AMBIENT +5 °C - +40 °C

RELATIVE HUMIDITY 20% - 80%

ENVIRONMENT CLEAN DUST FREE

CUSTOMER SIGNATURE: \_\_\_\_\_

DATE: \_\_\_\_\_

**NOTES:**

1. TECHNICAL DATA SUBJECT TO CHANGE WITHOUT NOTICE.
2. THIS PUMP MUST BE INSTALLED IN AN ENCLOSURE.
3. ALL DIMENSIONS ARE FOR REFERENCE ONLY.
4. KIT P/N: K965

**PRODUCT PERFORMANCE:**

50Hz CURVES BASED ON 230V.  
 60Hz CURVES BASED ON 115V.

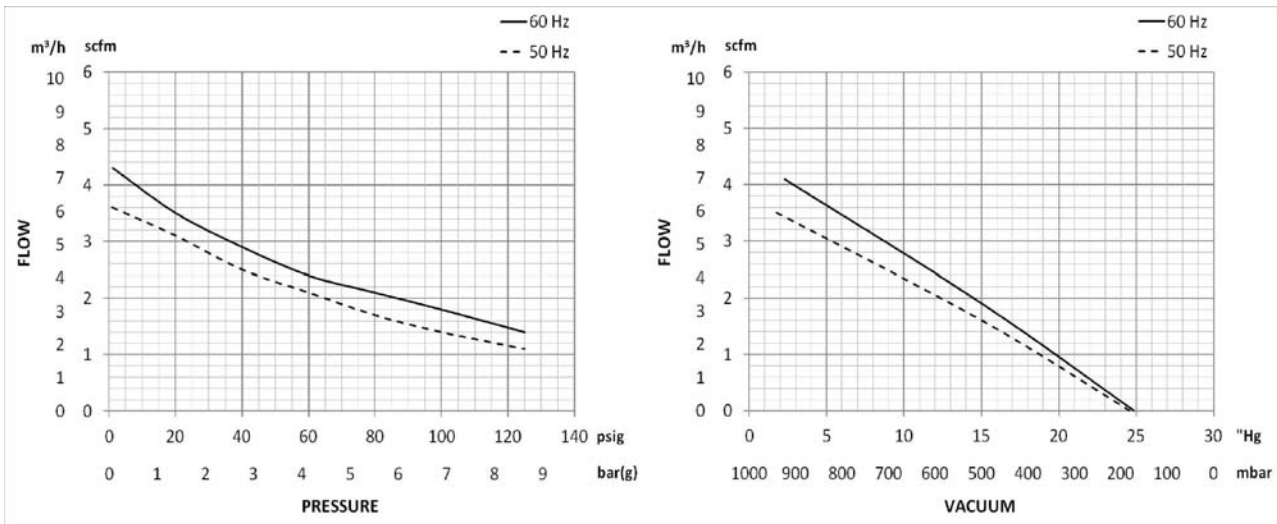

**PRODUCT DIMENSIONS:**

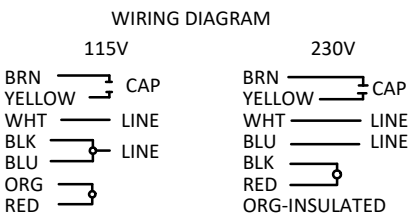

\*CAPACITOR HAVE CONNECTED.

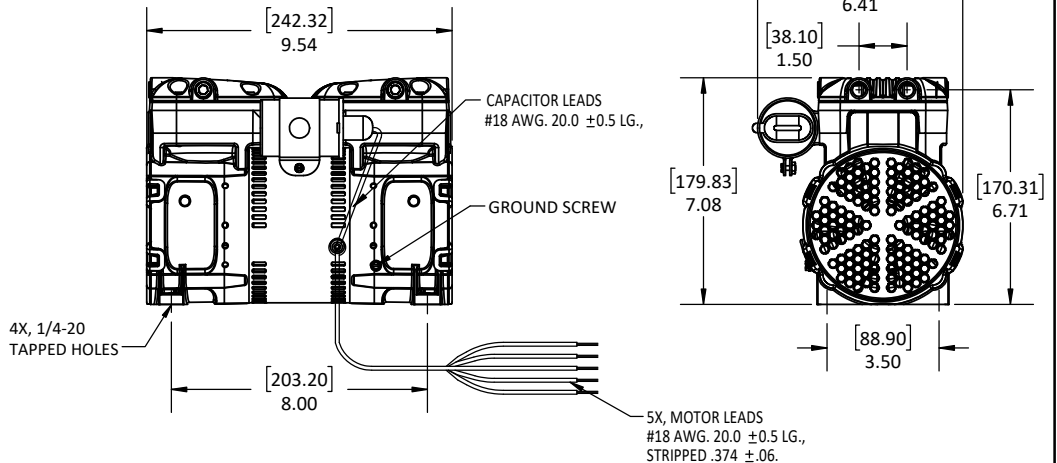
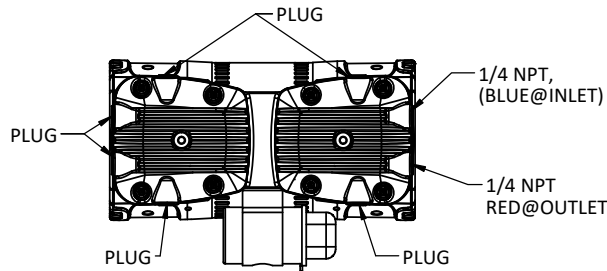
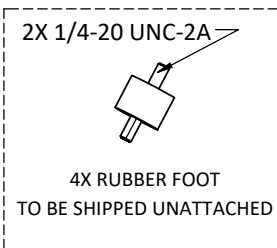

## 产品说明:

产品型号	电机电压	转速		电流		HP	kW	净重		电容	
		60HZ	50HZ	60HZ	50HZ			lbs.	kg	mfd.	VOLT
87R642-443R-N470X	115-120/230-240 (60Hz) 110-120/220-240 (50Hz)	1725	1425	5.7/2.8	5.1/2.6	1/2	0.37	19.1	8.6	30	370

噪音: <65 db(A)

正常使用环境温度: +5°C - +40°C

相对湿度: 20% - 80%

环境: 无尘

客户签名: \_\_\_\_\_

日期: \_\_\_\_\_

### 备注:

1. 本技术参数表如有更新恕不通知;
2. 请将泵安装在一个外壳内, 否则出于安全考虑, 请安装风扇盖;
3. 所有尺寸仅供参考;
4. 维修包料号: K965;

## 产品性能:

50Hz 时, 电压 230V.  
 60Hz 时, 电压 115V.

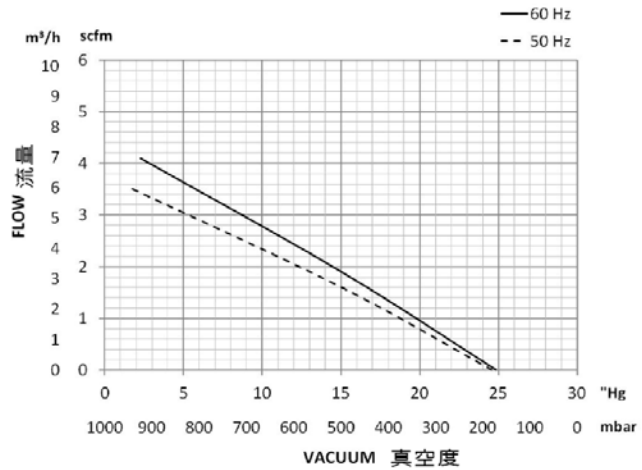
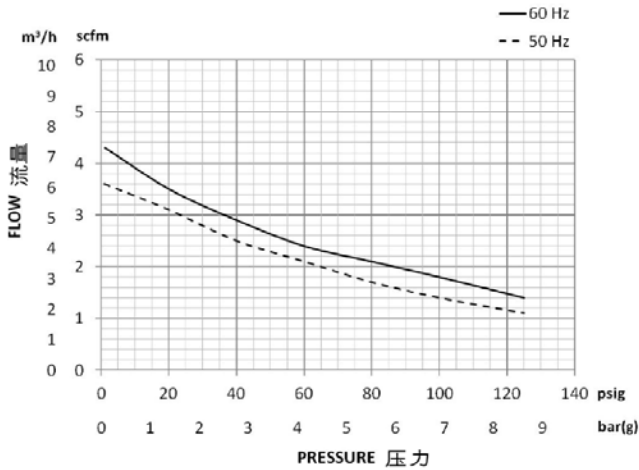

## 产品尺寸:

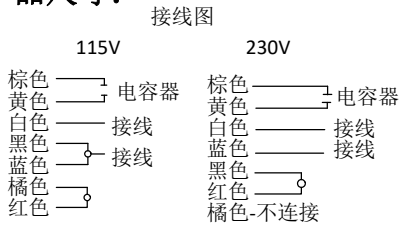

\*电容器已经预接好

